

MODEL: **Delabie DLB-1466040**

# DELABIE

## FEATURES & BENEFITS

- Automatic hot water shut off in case of cold water supply failure.
- Minimum flow rate required to operated: 5 lpm.
- Integrated non-return valves.
- Thermal shocks can be undertaken without special equipment.

## MAINTENANCE & CLEANING

Cleaning chrome: Do not use abrasive, chlorine or acid-based cleaning products. Avoid contact with concentrated bleach. Clean with soapy water using a cloth or sponge.

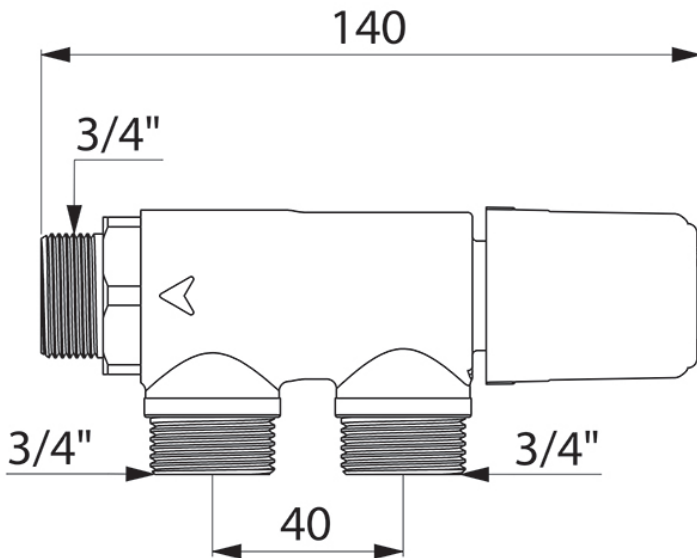

Dimensions are in millimeters. If a Cad file is required please visit [www.mechline.com](http://www.mechline.com).



MECHLINE DEVELOPMENTS LIMITED

Tel: +44 (0)1908 261511 | Email: [info@mechline.com](mailto:info@mechline.com) | Web: [www.mechline.com](http://www.mechline.com)