

MODEL:

AquaTechnix TX-B-316L

AQUATECHNIX

AquaTechnix LEVER operated faucet TX-B-30 base with 400mm swivel spout. H: 334mm

Model range: TX-30
Base: TX-B-30
Pedestal: Twin Hole
Mount: Deck mounted
Water feed: Twin
Controls: Lever
Connections: 1/2-inch
Tap type: Twin Mixer
Spout: 400mm swivel
Accreditation: WRAS

FEATURES & BENEFITS

- Ergonomic in design and functionality.
- Modern, hygienic and practical design comes pre-assembled ready to install.
- All assembled models are factory tested up to 6 bar for quality assurance.
- Complete interchangeability between all bodies, spouts and pre-rinse means that product use can easily be changed on site at a later date.
- Includes PosiStop protected lever and dome heads for long life and reliability for all models
- NOTE: When ordering a LEVER operated 30 range model for dish washing stations you will need a minimum of 120mm clearance for the lever handles when in the 'OPEN' position. We recommend your order DOME models for this application.

TECHNICAL INFO

- Connections: 1/2-inch
- Height: 334mm
- Recommended static water pressure range: 1.5 - 5 bar
- Flow rates for all TX-B-30 models - tested at 3 bar pressure: Fitted with WATER-SAVING diffuser: 3.70 l/m (INCLUDED) Fitted with STANDARD diffuser: 9.33 l/m

MAINTENANCE & CLEANING

Cleaning chrome: Do not use abrasive, chlorine or acid-based cleaning products. Avoid contact with concentrated bleach. Clean with soapy water using a cloth or sponge.

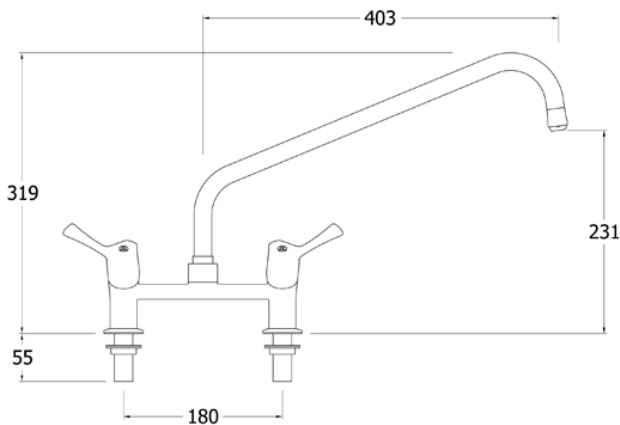

Dimensions are in millimeters. If a Cad file is required please visit www.mechline.com.



MECHLINE DEVELOPMENTS LIMITED

Tel: +44 (0)1908 261511 | Email: info@mechline.com | Web: www.mechline.com