



LBR2 - Lincat Lynx 400 Electric Counter-top Boiling Top - Twin Plate - W 565 mm - 3.0 kW

Perfect for use both in-kitchen and in buffet and mobile catering operations, the 2 x 1.5kW Twin Plate Boiling Top is quick, with variable heat control.

- ✓ Compact and hard wearing boiling top, ideal for the kitchen and for use in buffet and mobile catering operations.
- ✓ Automatic power reduction, if pan boils dry or is removed - prolonging hotplate life
- ✓ Variable heat control
- ✓ Fully pressed and sealed hob tops make the unit easy to clean and maintain

Specifications

Summary

Brand	Lincat
Range	Lynx 400
Power Type	Electric
Unit Type	Counter-top
Available in UK Only	No
UK Warranty	2 Years Parts and Labour Warranty
Export Warranty	Contact your local dealer
GTIN	5056105101079

Power and Performance

Total Power kW	3.0
IP Rating	IP23
Temperature Control	Mechanical
Rating per Hob kW	1.5

Key Specifications

Number of Hobs	2
Shape of Hob	Round

Weights and Dimensions

Unit Height (External) mm	120
Unit Width (External) mm	565
Unit Depth (External) mm	400
Hob Dimensions mm	180
Net Weight Kg	9.7

Supply Connections

Requires Installation	No
Requires Electrical Supply	Yes
UK 3 Pin Plug	Yes
Requires Hardwiring	No
Electrical Supply Rating Watts	3,000
Single Phase Amps	13.0
Single Phase Voltage	230

Shipping

Packed Weight Kg	12
Packed Height cm	25
Packed Width cm	70
Packed Depth cm	55

Technical Picture

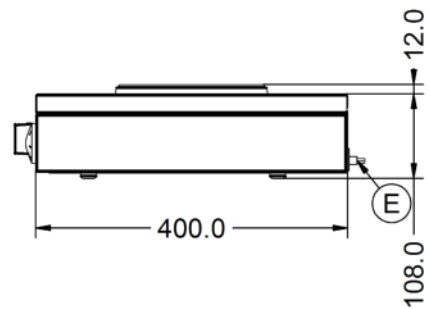
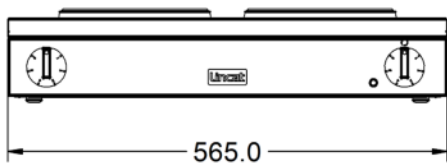
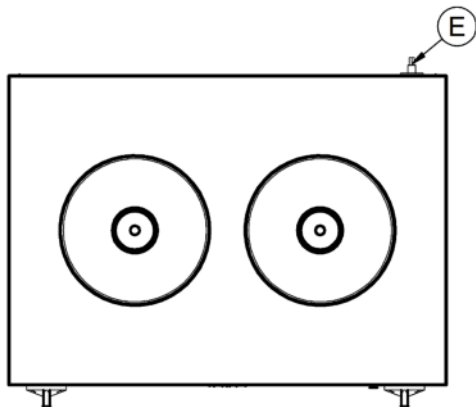

Lincat Limited

Whisby Road,
Lincoln, LN6 3QZ,
United Kingdom

Company No: 2175448

A member company of



Customer Care

Tel: +44 1522 875500
Email: care@lincat.co.uk

Export Customers

Tel: +44 1522 875536
Email: export@lincat.co.uk

Opening Hours

Monday – Friday:
8.30am – 5pm