

MODEL:

AquaJet AJPR20-HM-BF1-S

AQUAJET

AquaJet Pre-Rinse Spray. AJPR20 base / HANGMAN style / BF1 bowl filler / STANDARD gun

Model range: AquaJet 20
Base: AJPR20
Style: Hangman
Bowl filler: 150mm bowl filler (BF1)
Spray gun: Standard
Pedestal: Single
Mount: Deck mounted
Water feed: Twin Monobloc
Controls: Lever
Connect: 2x (M) 1/2-inch
Accredita: WRAS

FEATURES & BENEFITS

- A variety of choices to suit each application.
- WRAS approved across the range.
- Pre-assembled, ready to install - saves time on site.
- All assembled models are factory tested up to 6 bar for quality assurance.
- Choice of optional bowl fillers, water dispensing guns and accessories.
- Restraining device available to prevent hose from overstretching into basin, which reduces abuse and helps meet Water Board regulations.
- Super strong, food-grade, high-flow water hose.

TECHNICAL INFO

- Connections: 2x (M) 1/2-inch
- Tap hole req: 30mm
- Flow rates: 7.82 lpm tested at 3 bar pressure.

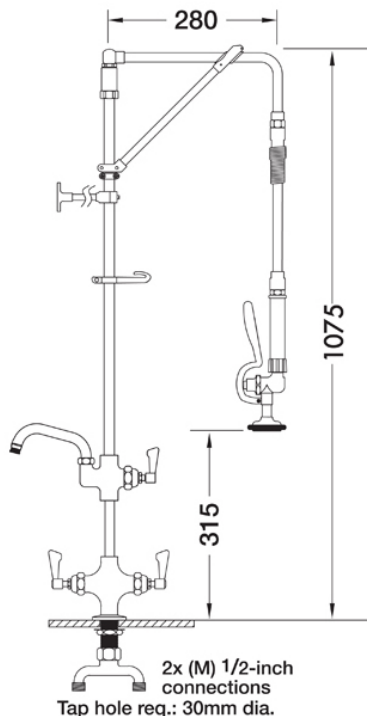

Dimensions are in millimeters. If a Cad file is required please visit www.mechline.com.

MAINTENANCE & CLEANING

Cleaning chrome: Do not use abrasive, chlorine or acid-based cleaning products. Avoid contact with concentrated bleach. Clean with soapy water using a cloth or sponge.



MECHLINE DEVELOPMENTS LIMITED

Tel: +44 (0)1908 261511 | Email: info@mechline.com | Web: www.mechline.com