

Magnum work desk

MODEL RANGE: MAXIMA | F20609Z |

Catering sinks | Work tops

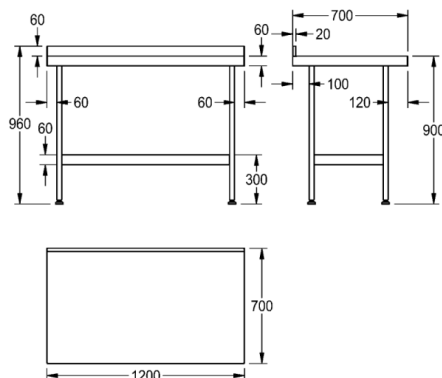
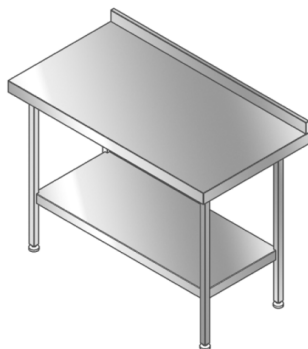

Magnum wall tables ideal to sit alongside the Magnum range of catering sinks. The mini wall tables are manufactured from 1.2 mm thick, grade 1.4301 (304) stainless steel with a satin polish finish. The stainless steel underframe and shelf is supplied flat pack with easy to read assembly instructions. Each leg is fitted with an adjustable foot (-20, +10 mm) with a working height of 900 mm.

Mini Wall table with flat pack underframe

Adjustable feet

Dimensions 1,200 x 700 x 900 mm (W x H x D)

Technical data

Material thickness	1.20 mm
Overall depth	700.00 mm
Overall height	900.00 mm
Overall width	1,200.00 mm
Material	Stainless steel
Material code	1.4301 Chrome Nickel steel V2A
Tailor made	No
Type of mounting	Floor mounting
Rear upstand	Yes
Surface finish	Satin finished
Product code	214.0000.135